

Collier - série lourde

■ Type: CCP-CS

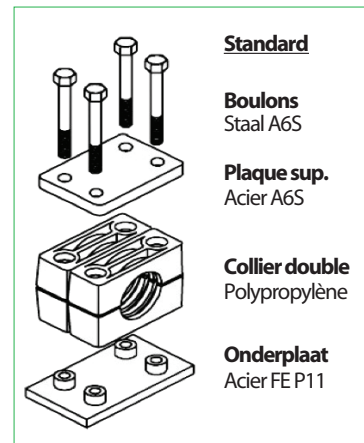
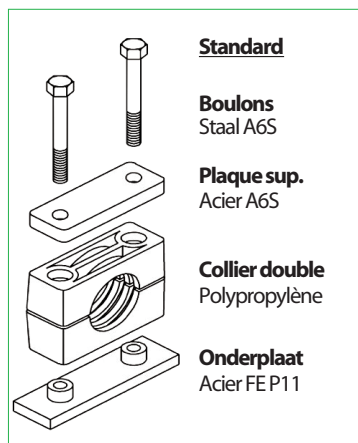
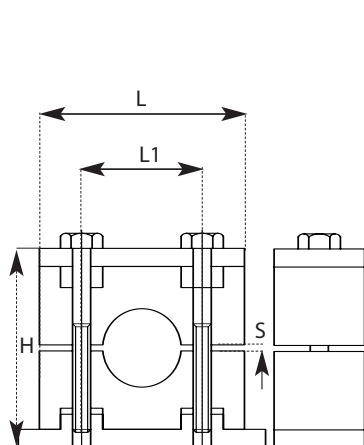

Collier lourde complète simple

Collier lourde complète double

Série	Diamètre des tubes			L mm	L1 mm	H mm	S mm	Réf. collier complète - simple	Réf. collier complète - double	Réf. collier (2 demies)
	ØD mm	DN Inch	OD Inch							
CP1	6			57	33	33	1	CCP1006CS	CCP1006CD	CP1006
CP1	6,35		1/4'	57	33	33	1	CCP1040DCS	CCP1040DCD	CP1040D
CP1	8			57	33	33	1	CCP1008CS	CCP1008CD	CP1008
CP1	9,52		3/8'	57	33	33	1	CCP1060DCS	CCP1060DCD	CP1060D
CP1	10	1/8'		57	33	33	1	CCP1010CS	CCP1010CD	CP1010
CP1	12			57	33	33	1	CCP1012CS	CCP1012CD	CP1012
CP1	12,7		1/2'	57	33	33	1	CCP1080DCS	CCP1080DCD	CP1080D
CP1	13,5	1/4'		57	33	33	1	CCP104CS	CCP104CD	CP104
CP1	14			57	33	33	1	CCP1014CS	CCP1014CD	CP1014
CP1	15			57	33	33	1	CCP1015CS	CCP1015CD	CP1015
CP1	16		5/8'	57	33	33	1	CCP1016CS	CCP1016CD	CP1016
CP1	17,2	3/8'		57	33	33	1	CCP106CS	CCP106CD	CP106
CP1	18			57	33	33	1	CCP1018CS	CCP1018CD	CP1018
CP1	19		3/4'	57	33	33	1	CCP1120DCS	CCP1120DCD	CP1120DCS
CP1	20			57	33	33	1	CCP1020CS	CCP1020CD	CP1020CS
CP2	19		3/4'	69	45	49	1	CCP2120DCS	CCP2120DCD	CP2120DCS
CP2	20			69	45	49	1	CCP2020CS	CCP2020CD	CP2020
CP2	21,3	1/2'		69	45	49	1	CCP208CS	CCP208CD	CP208
CP2	22		7/8'	69	45	49	1	CCP2022CS	CCP2022CD	CP2022
CP2	25			69	45	49	1	CCP2025CS	CCP2025CD	CP2025
CP2	25,4		1'	69	45	49	1	CCP2160DCS	CCP2160DCD	CP2160D
CP2	26,9	3/4'		69	45	49	1	CCP212CS	CCP212CD	CP212
CP2	28			69	45	49	1	CCP2028CS	CCP2028CD	CP2028
CP2	30			69	45	49	1	CCP2030CS	CCP2030CD	CP2030
CP3	30			84	60	60	1,2	CCP3030CS	CCP3030CD	CP3030
CP3	32		1.1/4'	84	60	60	1,2	CCP3032CS	CCP3032CD	CP3032
CP3	33,7	1'		84	60	60	1,2	CCP316CS	CCP316CD	CP316
CP3	35			84	60	60	1,2	CCP3035CS	CCP3035CD	CP3035
CP3	36			84	60	60	1,2	CCP3036CS	CCP3036CD	CP3036
CP3	38		1.1/2'	84	60	60	1,2	CCP3038CS	CCP3038CD	CP3038
CP3	40			84	60	60	1,2	CCP3040CS	CCP3040CD	CP3040
CP3	42,4	1.1/4'		84	60	60	1,2	CCP320CS	CCP320CD	CP320
CP3	43			84	60	60	1,2	CCP3043CS	CCP3043CD	CP3043
CP3	45			84	60	60	1,2	CCP3045CS	CCP3045CD	CP3045

- vervolg -

Collier - série lourde

■ Type: CCP-CS

Série	Diamètre des tubes			L mm	L1 mm	H mm	S mm	Réf. collier complète - simple	Réf. pijpbeugel complète - double	Réf. collier (2-demies)
	ØD mm	DN Inch	OD Inch							
CP4	33,7	1'		117	91	88	2	CCP416CS	CCP416CD	CP416
CP4	38		1.1/2'	117	91	88	2	CCP4038CS	CCP4038CD	CP4038
CP4	40			117	91	88	2	CCP4040CS	CCP4040CD	CP4040
CP4	42,4	1.1/4'		117	91	88	2	CCP420CS	CCP420CD	CP420
CP4	45		1.3/4'	117	91	88	2	CCP4045CS	CCP4045CD	CP4045
CP4	48,3	1.1/2'		117	91	88	2	CCP424CS	CCP424CD	CP424
CP4	50			117	91	88	2	CCP4050CS	CCP4050CD	CP4050
CP4	50,8		2'	117	91	88	2	CCP432ODCS	CCP432ODCD	CP432OD
CP4	53			117	91	88	2	CCP4053CS	CCP4053CD	CP4053
CP4	54	1.3/4'		117	91	88	2	CCP428CS	CCP428CD	CP428
CP4	55			117	91	88	2	CCP4055CS	CCP4055CD	CP4055
CP4	56			117	91	88	2	CCP4056CS	CCP4056CD	CP4056
CP4	57,2		2.1/4'	117	91	88	2	CCP436ODCS	CCP436ODCD	CP436OD
CP4	60,3	2'		117	91	88	2	CCP432CS	CCP432CD	CP432
CP4	63,5		2.1/2'	117	91	88	2	CCP440DCS	CCP440DCD	CP440D
CP4	65			117	91	88	2	CCP4065CS	CCP4065CD	CP4065
CP4	70		2.3/4'	117	91	88	2	CCP4070CS	CCP4070CD	CP4070
CP5	60,3	2'		155	122	118	3	CCP532CS	CCP532CD	CP532
CP5	65			155	122	118	3	CCP5065CS	CCP5065CD	CP5065
CP5	66	2.1/4'		155	122	118	3	CCP536CS	CCP536CD	CP536
CP5	70		2.3/4'	155	122	118	3	CCP5070ODCS	CCP5070ODCD	CP5070OD
CP5	73			155	122	118	3	CCP5073CS	CCP5073CD	CP5073
CP5	76	2.1/2'	3'	155	122	118	3	CCP540CS	CCP540CD	CP540
CP5	80			155	122	118	3	CCP5080CS	CCP5080CD	CP5080
CP5	85			155	122	118	3	CCP5085CS	CCP5085CD	CP5085
CP5	88,9	3'	3.1/2'	155	122	118	3	CCP548CS	CCP548CD	CP548
CP5	90			155	122	118	3	CCP5090CS	CCP5090CD	CP5090
CP6	100			205	168	165	3	CCP6100CS	CCP6100CD	CP6100
CP6	101,6		4'	205	168	165	3	CCP664ODCS	CCP664ODCD	CP664OD
CP6	102	3.1/2'		205	168	165	3	CCP656CS	CCP656CD	CP656
CP6	108		4.1/4'	205	168	165	3	CCP6108CS	CCP6108CD	CP6108
CP6	114,3	4'	4.1/2'	205	168	165	3	CCP644CS	CCP644CD	CP644
CP6	121			205	168	165	3	CCP6121CS	CCP6121CD	CP6121
CP6	126,5	4.1/2		205	168	165	3	CCP672CS	CCP672CD	CP672
CP6	127		5'	205	168	165	3	CCP6127CS	CCP6127CD	CP6127
CP7	127		5'	255	205	200	4	CCP7127CS	CCP7127CD	CP7127
CP7	133		5.1/4'	255	205	200	4	CCP7133CS	CCP7133CD	CP7133
CP7	140	5'		255	205	200	4	CCP780CS	CCP780CD	CP780
CP7	146			255	205	200	4	CCP746CS	CCP746CD	CP746
CP7	150		6'	255	205	200	4	CCP7152CS	CCP7152CD	CP7152
CP7	159		6.1/4'	255	205	200	4	CCP7100ODCS	CCP7100ODCD	CP7100
CP7	168	6'		255	205	200	4	CCP796CS	CCP796CD	CP796
CP8	168	6'		320	265	270	4	CCP596ODCS	CCP596ODCD	CP596OD
CP8	177			320	265	270	4	CCP8177CS	CCP8177CD	CP8177
CP8	193			320	265	270	4	CCP8193CS	CCP8193CD	CP8193
CP8	203		8'	320	265	270	4	CCP8128ODCS	CCP8128ODCD	CP8128OD
CP8	219	8'		320	265	270	4	CCP8128CS	CCP8128CD	CP8128
CP9	219	8'		470	395	410	10	CCP9128CS	CCP9128CD	CP9128
CP9	273	10'		470	395	410	10	CCP9273CS	CCP9273CD	CP9273
CP9	324	12'		470	395	410	10	CCP9324CS	CCP9324CD	CP9324

Collier complète

CCP CS/CD = colliers en polpropylène / pièces en acier

PCCP CS/CD = colliers en polyamide / pièces en acier

Standaard

Collier complète

RCCP CS/CD = colliers en polpropylène / pièces en inox 316L

RPCCP CS/CD = colliers en polyamide / pièces en inox 316L

Pièces détachées collier standard- série lourde

Plaque inférieure - acier - exécution simple

■ Type: PICP CS

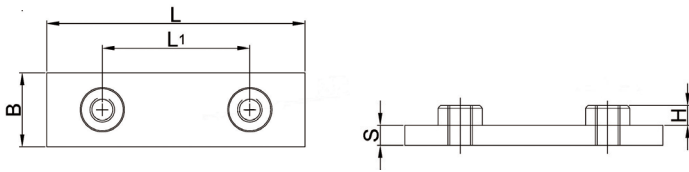

Série	L mm	L1 mm	B mm	H mm	S mm	Réf.
C1	74	33	30	8	8	PICP1CS
C2	86	45	30	8	8	PICP2CS
C3	100	60	30	8	8	PICP3CS
C4	140	90,5	45	8	10	PICP4CS
C5	180	122	60	9,5	10	PICP5CS
C6	226	168	80	17	15	PICP6CS
C7	270	205	90	21	15	PICP7CS
C8	340	265	120	25	25	PICP8CS
C9	520	395	160	25	30	PICP9CS

Exécution standard: acier zingué (blanc)

Exécution inox: R + Réf

Plaque inférieure - acier - exécution double

■ Type: PICP CD

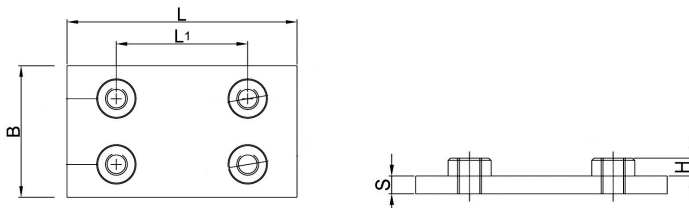

Série	L mm	L1 mm	B mm	H mm	S mm	Réf.
C1	70	33	60	8	8	PICP1CD
C2	87	45	60	8	8	PICP2CD
C3	105	60	60	8	8	PICP3CD
C4	140	90,5	90	8	10	PICP4CD
C5	180	122	120	9,5	10	PICP5CD
C6	226	168	160	17	15	PICP6CD
C7	270	205	180	21	15	PICP7CD
C8	340	265	240	25	25	PICP8CD
C9	520	395	320	25	30	PICP9CD

Exécution standard: acier zingué (blanc)

Exécution inox: R + Réf

Plaque supérieure - acier - exécution simple

■ Type: PSCP CS

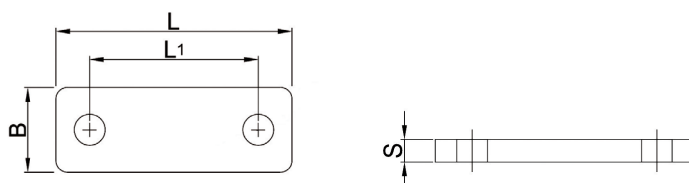

Série	L mm	L1 mm	B mm	S mm	Réf.
C1	57	33	30	8	PSCP1CS
C2	69	45	30	8	PSCP2CS
C3	84	60	30	8	PSCP3CS
C4	117	90,5	45	10	PSCP4CS
C5	152	122	60	10	PSCP5CS
C6	205	168	80	15	PSCP6CS
C7	251	205	90	15	PSCP7CS
C8	320	265	120	25	PSCP8CS
C9	470	395	160	30	PSCP9CS

Exécution standard: acier zingué (blanc)

Exécution inox: R + Réf

Plaque superieure - acier - exécution double

■ Type: PSCP CD

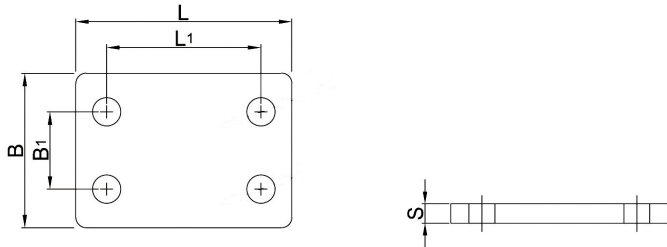

Série	L mm	L1 mm	B mm	B1 mm	S mm	Réf.
C1	57	33	60	31	8	PSCP1CD
C2	69	45	60	31	8	PSCP2CD
C3	84	60	60	31	8	PSCP3CD
C4	117	90,5	90	46	10	PSCP4CD
C5	155	122	120	61	10	PSCP5CD
C6	205	168	160	81	15	PSCP6CD
C7	251	205	180	91	15	PSCP7CD
C8	320	265	240	121	25	PSCP8CD
C9	470	395	320	162	30	PSCP9CD

Exécution standard: acier zingué (blanc)

Exécution inox: R + Réf

Plaque de blocage - acier

■ Type: PBCP

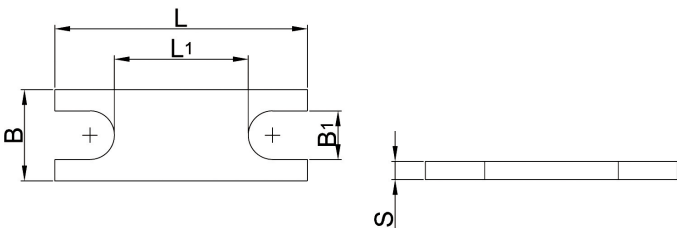

Série	L mm	L1 mm	B mm	B1 mm	S mm	Réf.
C1	55	11	30	16	6	PBCP1
C2	69	25	30	16	6	PBCP2
C3	83	39	30	16	6	PBCP3
C4	114	66	45	18	6	PBCP4
C5	148	95	60	22	6	PBCP5
C6	195	132	80	28	6	PBCP6
C7	250	166	90	31	15	PBCP7
C8	310	210	120	47	8	PBCP8
C9	-	-	-	-	-	PBCP9

Exécution standard: acier zingué (blanc)

Exécution inox: R + Réf

Rail

■ Type: RAIL

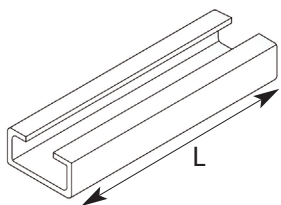

L mm	H2 mm	B mm	H1 mm	Ref rail
2000	22	40	4,5	RAIL*4022

Exécution standard: acier zingué (blanc)

Exécution inox: * = 'R'

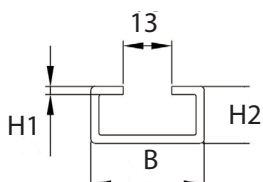

Ecroû et joint pour monatge rail

■ Type: DFPM en AGP

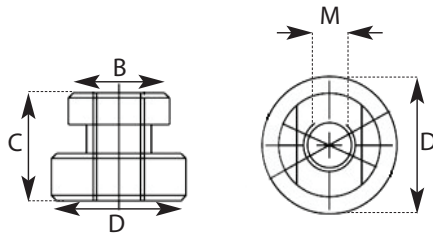

Série	M metr.	B mm	C mm	D mm	Réf Ecrou	Réf Joint
C1	M10	17,7	20,5	26	DFPM10	AGPM10
C2	M10	17,7	20,5	26	DFPM10	AGPM10
C3	M10	17,7	20,5	26	DFPM10	AGPM10
C4	M12	19,6	23	26	DFPM12	AGPM12

Exécution standard: acier zingué

Boulons

■ Type: inbus - hexagonal - intermédiaire

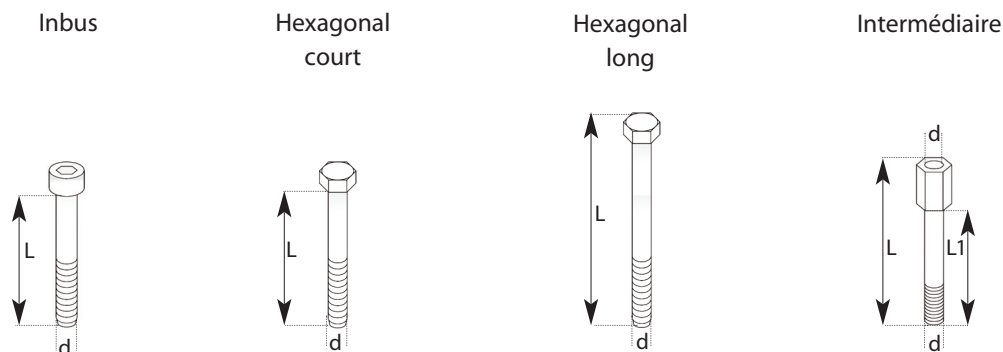

Série	BVID Inbus	Référence	BVZD Hexagon.court	Référence	BVZD Hexagon.long	Référence	BVOD Intermédiaire	Référence	L mm	L1 mm
C1	M10x30	BVID10x30	M10x45	BVID06x22	M10x80	BVZD10x80	M10x49	BVOD10x49	49	28
C2	M10x45	BVID10x45	M10x60	BVID06x22	M10x110	BVZD10x110	M10x65	BVOD10x65	65	42
C3	M10x55	BVID10x55	M10x70	BVID06x28	M10x130	BVZD10x130	M10x75	BVOD10x75	75	52
C4	M12x80	BVID12x80	M12x100	BVID06x30	M12x190	BVZD12x190	M12x108	BVOD12x108	108	78
C5	M16x110	BVID16x110	M16x130	BVID06x40	M16x250	BVZD16x250	M16x144	BVOD16x144	139	105
C6	M20x150	BVID20x150	M20x190	BVID06x50	-	-	M20x190	BVOD20x190	190	150
C7	M24x190	BVID24x190	M24x220	BVID06x60	-	-	M30x240	BVOD24x240	240	180
C8	-	-	M30x300	BVID06x85	-	-	M45x315	BVOD30x315	315	200
C9	-	-	M30x450	BVID06x110	-	-	-	-	-	-

Exécution standard: acier zingué

Exécution inox: 'BV..' = 'BR..'